

# EASY



## Digital burette, EASY 70

*Please read the User Manual carefully before use, and follow all operating and safety instructions!*



# user manual

english

# User manual



## Digital burette, EASY 70

### Introduction

Users must read this manual carefully before using the equipment and follow the instructions and procedures in order to be aware of all the precautions, as well as to obtain the maximum benefits and duration of the equipment.

### Service

If help is needed, contact with your supplier/manufacturer or Labbox via: [www.labbox.com](http://www.labbox.com)





Please, provide the customer service representative with the following information:

- Serial number (on the back side)
- Description of the problem
- Your contact information

### Warranty

This instrument is guaranteed to be free from defects in materials and workmanship under normal use and service, for a period of 24 months from the date of invoice. The warranty is extended only to the original purchaser. It shall not apply to any product or parts which have been damaged on account of improper installation, improper connections, misuse, accident or abnormal conditions of operation. For claim under the warranty, please contact your supplier.

# 1. Safety instructions

	Connect the equipment to a grounded power supply to ensure the safety of the equipment and the experiment. Connect the power when the equipment requires it.
	Place the Digital burette EASY 70 on a flat, horizontal, and stable table, leaving at least 30 cm of free space on each side. Make sure that the surface is adequate for the device's weight.
	The Digital burette EASY 70 must be used only by previously qualified staff that is familiar with the equipment and knows how to operate it according to the instruction manual.
	Caution – the Digital burette EASY 70 can have magnetic effects and the staff must keep in mind the magnetic field; for example, in cases like data storage, artificial pacemakers...
	Carefully read the instructions in this manual before using the device.

- Do not operate this instrument in any manner not described in this 'User manual'.
- Ensure that the electrical outlet matches the voltage and power required for this equipment.
- In case of abnormal circumstances during the manipulation of the digital Burette EASY 70, please turn off the equipment and contact your supplier.
- Keep the equipment away from high electromagnetic fields.
- The liquid-path of your digital burette is made of borosilicate glass, FEP and PTFE. Do not apply it in handling liquids like hydrofluoric acid.
- The instrument could become clogged or damaged by solid particles in a turbid liquid such as activated carbon.
- The plastic parts of your digital burette could be in swelling condition if concentrated acid, alkaline acid, methylbenzene, benzene and other nonpolar organic solvents are put into use.
- Keep your digital burette away from the highly combustible carbon disulfide.
- Keep the equipment out of corrosive atmospheres.
- The equipment can only be disconnected from the socket by pulling on the base of the plug, not the cable.
- Digital burette cannot be autoclaved.
- Do not put your digital burette in contact with corrosive gas like HCL smog.
- The precautions described in this 'User manual' are carefully developed in an attempt to cover all the possible risks. However, it is also important that you are alert for unexpected incidents.

## 2. Use instructions

This equipment is designed for titrating and/or stirring substances with educational purposes, in laboratories or industry. This equipment is not suitable for use in residential areas or other areas that could be dangerous for the user.

## 3. Inspection

### 3.1. Unpacking

Unpack the equipment carefully and check for any apparent damages that may have arisen from transportation. If necessary, please contact your supplier.



**Note:**

If there is any apparent damage to the equipment, do not plug it into the power line.

### 3.2. Items list

The package includes the following items:

Items	Qty
Titration pipe	1
Titration pipe cover	1
Digital burette	1
AC Adapter	1
Controller	1
cable USB	2
Bottle Adapter	5 (GL32; GL38; GL28; GL25; S40)
Magnetic Stirrer	1
Remote Titration pipe	1
Remote Control Handle	1
Stirrer Bar	1 (20 mm)
Filling valve	1
Dispensing valve	1
Filling pipe	2
Installation tools	1
Stand	1

Please check that all the items are present and inform your supplier immediately if any of the above is missing.

## 4. Control

### 4.1 Digital burette

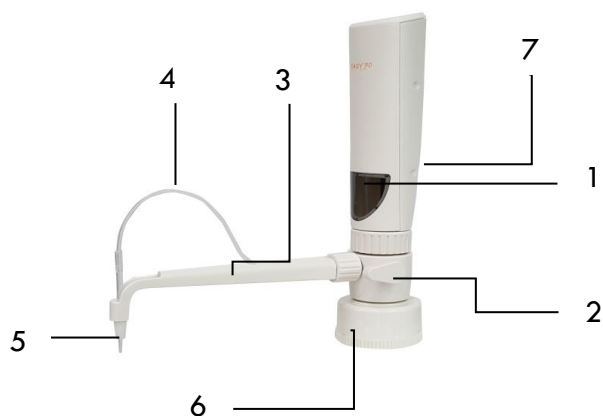

1. Liquid level and piston indicator
2. Return valve
3. Titrating pipe
4. Titrating pipe cover
5. Titrating pipe tip
6. Bottle adapter
7. Controller port micro-USB

### 4.2 Magnetic Stirrer



1. Stirring Plate
2. USB - Communication port
3. Fastening key

### 4.3 Control Panel



1. LCD display
2. Filling controller
3. Dispensing controller
4. Setting/magnetic stirrer
5. Pre-filling controller
6. Knob



The control panel can be adjusted up to an angle of 45°

1. Magnetic stirrer data port (USB)
2. Sensor holder assembly slot
3. Magnetic stirrer fastening slot

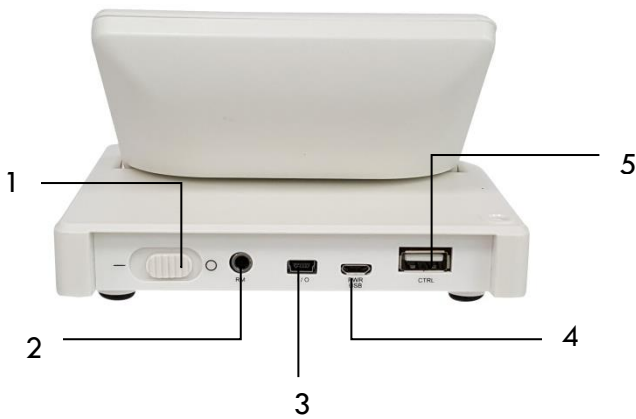

1. Power switch
2. Remote control handle port
3. Communication port (non-function)
4. Charging/communication port
5. Main instrument port

#### 4.4 Remote Control Handle

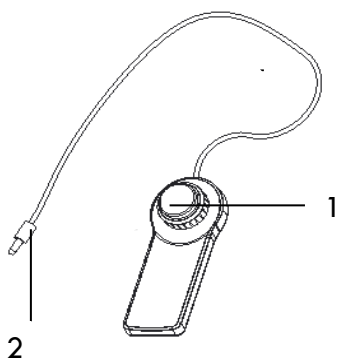

1. Control knob
2. Data connector

#### 4.5 Display

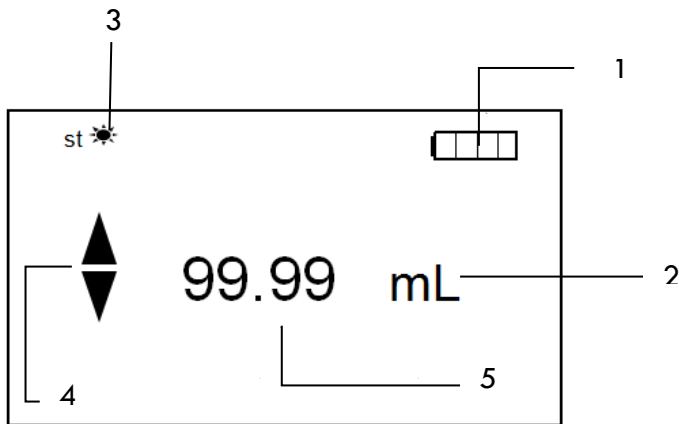

1. Battery indicator
2. Unit
3. Magnetic stirring indicator
4. Indication arrow (piston movement)
5. Liquid volume

### 5. Assembly Instruction

- Turn the main instrument lock clockwise to connect titrating tip with main body. It is possible that this step has already been done.

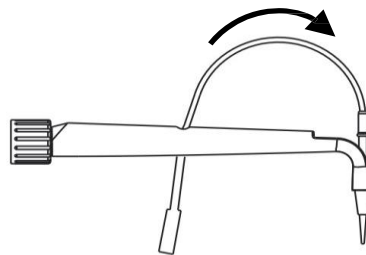

- Place the titrating pipe tail end into the location slot.

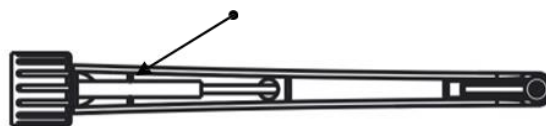

- Push the titration tail tube to a certain extent, so that the end of the tube protrudes from the main body.



- Connect the titration pipe tail end with the dispensing valve.

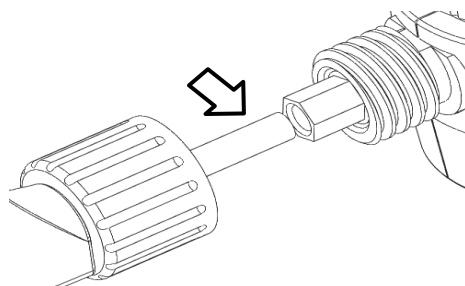

EASY

- Lock the titration pipe turning clockwise.

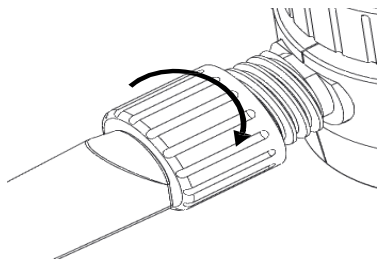

**Note:**

The titration pipe is made of FEP. You can confirm the compatibility with other substances in chapter 13.

- Connect the filling pipe with filling valve, located in the lower part of the main body of the burette.

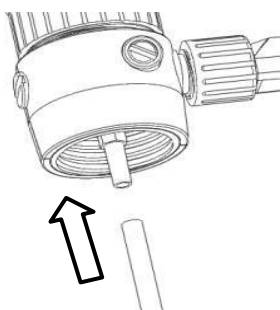

- Choose a suitable bottle adapter and then connect it with digital burette main body.

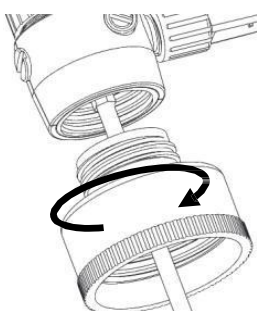

- Turn bottle adapter to fasten main body and bottle.

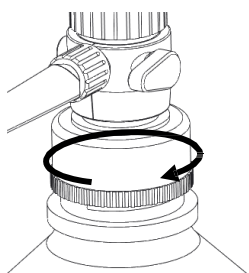



**Note:**

- Please ensure that the adapter is fastened prior to each use.
- For perfect titration, please do not move or touch the instrument during operation to avoid any damage to the EASY 70 device.

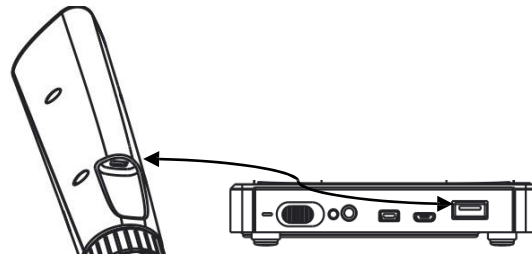

- Use the USB cable to connect the main instrument with the controller. The slot is located behind the burette.

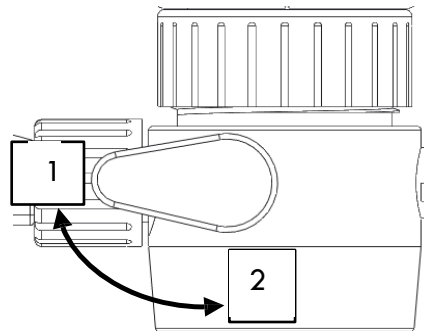

- Turn return valve to position 1. In order to pour off the barrel turn return valve to direction 2 Easy70's system is ready to operate.



## 6. Operation Test



- Ensure that the socket is properly grounded.
- Plug the power cable into the system, then into the outlet. Make sure the power is on.
- Refill the bottle with water and connect the burette to the top of the bottle, following the steps previously explained.
- Power on the instrument; the power button is in the back of the controller.
- Wait until the self-check cycle is completed.
- Do a complete cycle of filling in and dispensing before the first-time work:
  - Suction: Hold the filling button . The burette will automatically fill up with the liquid. Once the burette is full, it will emit a double sound.
  - Dispensing: Hold dispensing button  for fast titration. Once the burette has emptied all the liquid, it will emit a double sound.
- The cycle of filling and dispensing needs to be done at least twice more.

- If the previous action has been carried out correctly, the EASY 70 device is ready to operate.

## 7. Operation

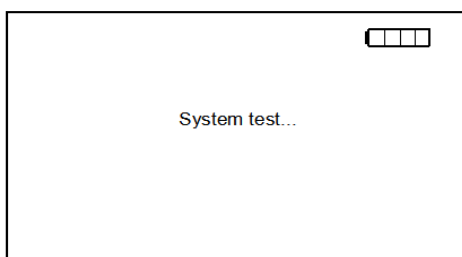
- Place the Digital burette on top of a horizontal, flat, and stable table making a free space of at least 30 cm on each side. Do not put the stirrer near any warm supply.
- Add the substance to titrate in the bottle. Immediately, introduce the digital burette in the top part of the bottle.
- Verify that filling pipe reaches the bottom of the bottle for a complete suction.
- Plug the equipment to the electric current; turn on the EASY 70 with the power button.
- Wait until the self-check is complete.





- Hold the pre-filling button  2 seconds to do the vacuum, the piston shall be at the bottom of the barrel.
- Press and hold the button  so the burette fills up with the substance to titrate, until the indicator Arrow shows that the piston is moving downwards.
- To titrate the sample there are two methods, to perform a quick valuation, hold the button . If the wished method is drop-to-drop, turn the knob clockwise.
- The liquid volume will be recorded continuously, and it will appear on the screen. If you want to record a new volume, press the control and the volume will be restored.
- If you want to introduce the magnetic agitator, see the paragraph 8 "Accessories".

	<p><b>Note:</b></p> <p>When the recorded volume reaches the maximum value (99.99 ml) the instrument will stop. Press the knob to reset liquid volume to zero.</p>
---	---

### 7.1 Liquid Emptying

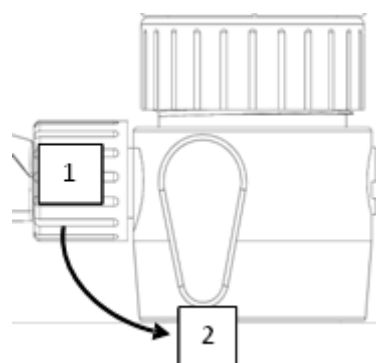
- If the liquid needs to be emptied from the barrel to the bottle:
  - Turn Return Valve to direction 2.



Keep pressed the dispensing button  until the piston is at the barrel end, make sure all the liquid in the burette has been poured into the bottle.

- Turn the return valve to position 1. Emptying operation has been completed.

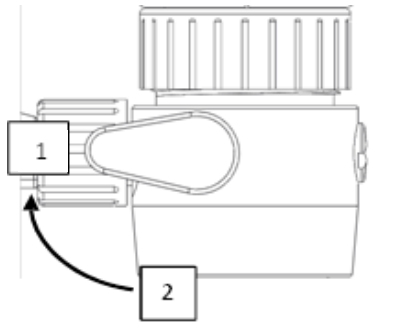

## 7.2 Function Setting

If you want to realize adjustments of valuation such as how to change the suction speed of the burette, to vary the speed of the magnetic stirrer, proceed as follows:

- Hold the setting button for about 2 seconds to enter Function Setting interface.
- Press Setting button to flick through pages.
- Hold again the setting button for 2 seconds to exit the function setting interface.

• **Suction speed:** To change the suction speed within a range of 1-16. Turn the knob to adjust and press to confirm.

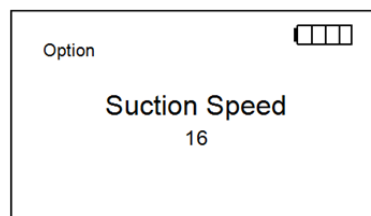

• **Dispensing speed:** To change the dispensing speed within a range of 1-16. Turn the knob to adjust and press to confirm.

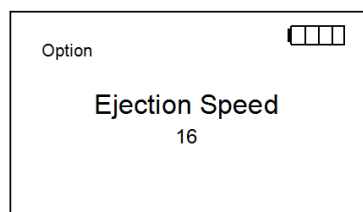

- **Magnetic stirrer speed:** To change the stirring speed within a range from 0 to 5. Turn the knob to adjust and press to confirm.

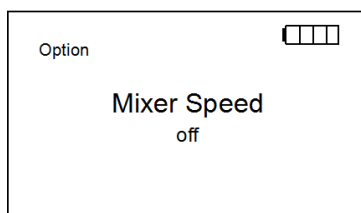

**Note:** This function is only effective after connecting the magnetic stirrer. Go to chapter 8 “Accessories” to install it.

## 8. Accessories

### 8.1. Remote Control Handle

The remote control allows you to perform valuation functions from a farther distance.

- Turn Knob for dropwise titrating.
- Press the button to reset liquid volume record.
- Hold 2 seconds the button for fill up the burette.

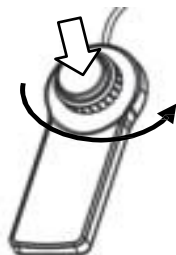

**MAX. Length: 90 cm**

### 8.2. Magnetic Stirrer

In order to install the magnetic stirrer conveniently for mixing during the titration experiments, follow the instructions:

- Connect the control panel with the magnetic stirrer to the indicated slot. The Magnetic stirrer will have to be in vertical position.

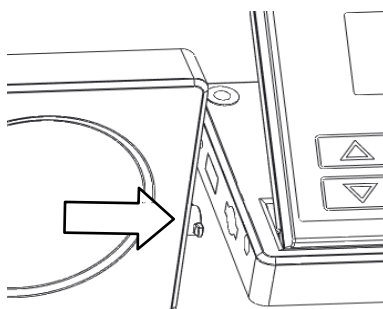

EASY

- Turn the Magnetic Stirrer into horizontal position so that the elements are well fixed.

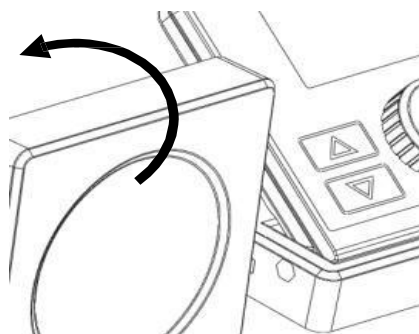

- Connect the USB Port under the Magnetic Stirrer with the Control Panel.

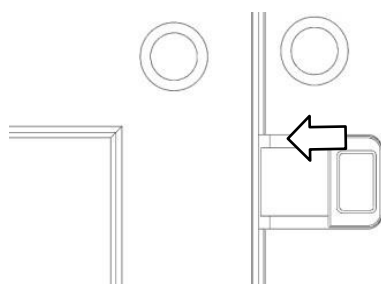

### 8.3 Assembly Sensor Holder

The support will allow you to place, the remote pipe or any kind of sensor. If you want to install it, follow these indications:

- Fasten the metallic support into place.

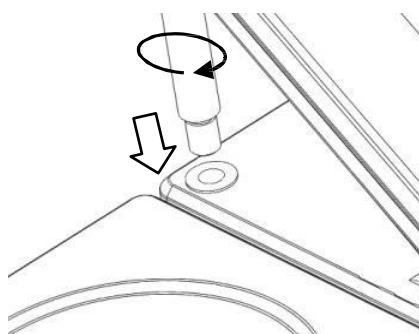

- Press the black button on the clamp and introduce the holder through, release the button when is located at the desired height and the clamp will remain fixed.

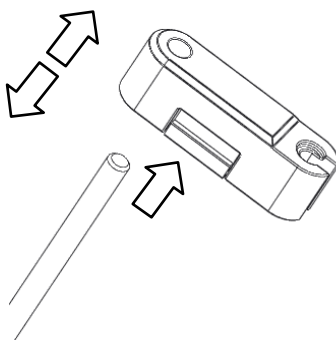

- Insert the smallest metal bar into the groove of the largest one so the support is well fixed.

### Assembly diagram

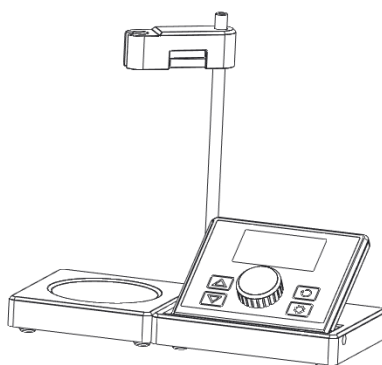

### 8.3. Remote Titrating pipe

Remote titrating pipe can effectively extend the titration distance. It shall be placed on the holder clamp. To install it, follow up the instructions:



MAX. Length 1.5m



Note:

- Titrating pipe are made of FEP. Please confirm compatibility prior to use (chapter 13)

- Connect the titration pipe tail end with the dispensing valve. Try not to force the material.

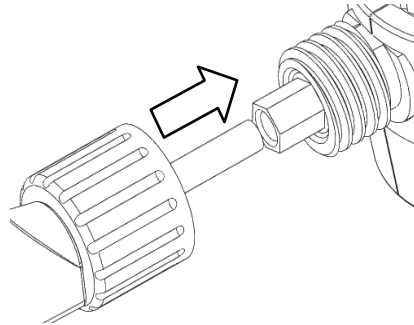

- Lock the titration pipe turning it clockwise.

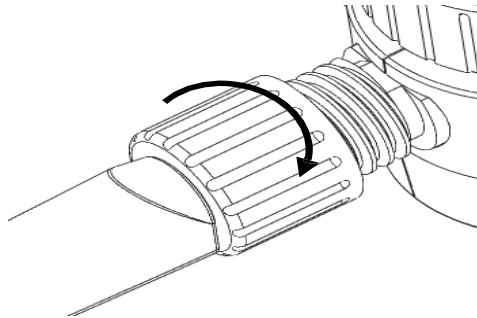

- Follow the figure to assemble the adapter and remote titrating pipe.

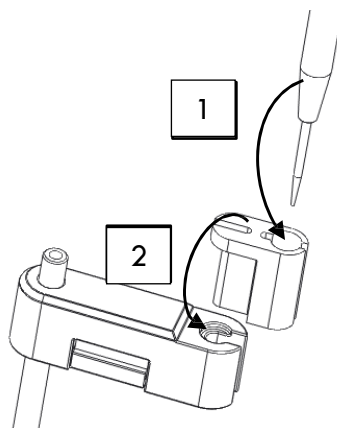

Introduce the adapter (1) in the clamp (2) and immediately afterwards connect the top of the pipe in the adapter (1).

## 9. Calibration

To perform the calibration of this equipment, the room must be in a temperature condition between 20 and 25 °C and kept constant within  $\pm 0.5^\circ\text{C}$ . The calibration software will record calibration values in your digital burette. The calibration shall be done weighing repeatedly distilled water at least five times.

Hardware needed:

- Electronic balance with readability of 0.01 mg
- Distilled water
- PC with operating system Windows (XP/Vista/7/8/10)

Software needed:

- Dedicated calibration software for EASY 70

(For more information, please contact with your nearest distributor.)

### 1. Software installation

The EASY 70 software provides a seamless interface for your titrator. To begin:

1. **Run the Installer:** Locate the installation package, double-click to open it, and follow the on-screen prompts to complete the setup.
2. **Initial Launch:** Once installed, open the application.
3. **Administrator Login:** Use admin for both the username and password to enter the system for the first time.

### 2. User Management

Before connecting the hardware, it is recommended to set up individual user accounts:

1. Navigate to the **User Management** section.
2. Select **Add New User**.
3. Assign a unique username and password, then select the **Operator** role.
4. **Save and Re-login:** Close the software completely, then log back in using your new personal credentials.

### 3. Connecting Your Titrator

You can connect the EASY 70 to your PC via Wi-Fi or a USB cable.

#### Option A: Wireless Connection (Wi-Fi)

*Prerequisite: Ensure both your PC and the titrator are connected to the same 2.4 GHz network.*

1. In the software, select **Wi-Fi** as your connection method.
2. Select your specific titrator model/capacity and log in.

3. On the physical titrator, navigate to the network settings and enter your Wi-Fi password.
4. **Pairing:** \* In the PC software, find the **Server** tab to view the PC's IP address.
  - Enter this IP address into the settings on the titrator controller.
  - The devices are now paired.

#### **Option B: Wired Connection (USB)**

1. Connect the titrator to your PC using the provided data cable.
2. In the software, select **USB** as the connection method.
3. Choose your equipment type.
4. Select **COM 7** from the port list and click **Connect**.

#### **4. Software Operation**

Once connected, the software mirrors the physical controller's interface, allowing you to operate the device directly from your PC.

- **Important:** Always perform an air purge before starting a titration to ensure accuracy.
- **Concentration Calculations:** The software includes three built-in formulas. As you titrate, the system calculates volume and concentration in real-time. Once finished, click **Save** and assign a sequence number to view the record later in the **History Data** tab.

#### **5. Calibration Guide**

Regular calibration is essential for precision.

**Note:** Please review the safety precautions in your user manual before beginning.

1. **Preparation:** Ensure your device is ready and click **Calibrate**.
2. **Environmental Input:** Input the current laboratory temperature when prompted.
3. **The Process:** The device will aspirate liquid. It will perform five cycles of dispensing 2,500 mL each.
4. **Data Entry:** For each of the five cycles, record the actual measured volume and input these values into the software.
  - *If you make a mistake, use the **Reset** button to clear the current entry.*
5. **Validation:** The software will automatically calculate the error margins. If the results are within the qualified range, you may proceed.
6. **Completion:** Repeat this process for the remaining two calibration steps (three steps total). Once all steps are complete, you can review the results, recalibrate if necessary, or click **Upload Data** to save the calibration profile directly to the device.

## 10. Cleaning and Maintenance

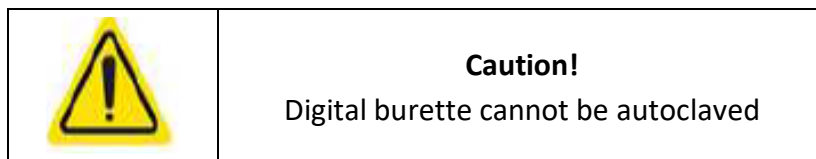

### 10.1. Cleaning the outer surface

The outer surface of your digital burette is made of ABS (Acrylonitrile butadiene styrene), ideal for easy cleaning with water.

### 10.2. Cleaning the barrel

For the cleaning of the burette, it is recommendable to use clean water. Fill up and dispense water at least 5 times, ensuring that the digital burette does not contain residues that may influence the next titration.

To perform a deep cleaning, proceed as follows:

- Replace the bottle with one with de-ionized water
- Turn return valve to direction 1, hold the pre-filling button and the piston will stop at the barrel bottom.

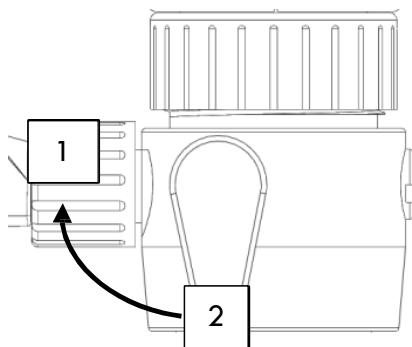

- Press filling and dispensing button to absorb and eject clean water at least 5 times.
- Hold the pre-filling button again so the piston stops at the barrel bottom.
- To empty completely the burette, turn the return valve to direction ②, press 'Dispensing button' so the piston runs to the end of the path.
- Finally, press the dispensing button; the remaining liquid will be emptied into the bottle, and the digital burette will be totally washed. Place the return valve on the position 1 and the washing will be finished.



**Caution:**

It is not recommended to remove and clean the digital burette barrel. If the barrel cleaning operation fails to meet the cleaning requirements of the user, please, contact the distributor.

Be sure to deliver the digital Burette without residual liquid and report the details of the last liquid used.

### 10.3. Filling and Dispensing valve replacements

In the box you will find 2 valve replacements (filling and dispensing valves) and a special tool to substitute them in case of failure.

Use the Installation tools to disassemble the old valve and replace with the new one to the same position.

Check section 11 "**Solving small faults**" to see which problems can occur while replacing the valves.

Before disassembling take these objections into account.

- Before disassembly make sure that the pipes have been removed.
- The dispensing valve is located at the connection of the burette body with the titration tube. Dismantling is done by turning the valve counterclockwise.

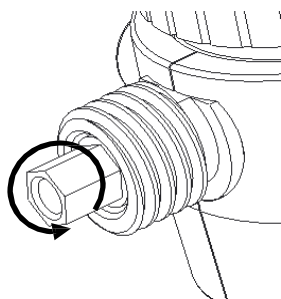

- The dispensing valve is located at the connection of the burette body with the bottle. Dismantling is done by turning the valve counterclockwise.

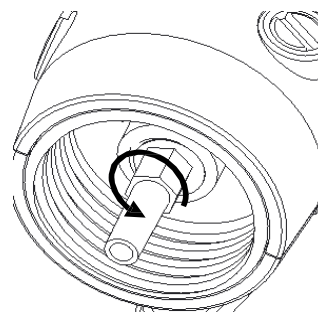

## 11. Trouble Shooting

- Piston overflows with liquid: Check that the piston is in good condition, piston wears off due to the use. Contact with your dealer if necessary.

- Piston moves with difficulty: Piston or its parts are contaminated or damaged due to crystallization and sedimentation of the titrated substances. Clean the barrel (section 10.2) or contact with your dealer.
- Failure to filling: If the liquid is transmitted to the titration tube automatically; the dispensing valve could be contaminated or titration tip damaged. Replace filling valve or contact with your provider.
- Bubbles in the instrument: Filling pipe could be loose or damaged, check if the filling pipe is submerged into the liquid. If the bubbles persist the filling pipe could be damaged, contact with your dealer.
- Dispensing volume is less than the volume displayed: It may be that the return duct is not installed or that it is in poor condition, to solve this fault contact your dealer. Moreover, it is possible that the filling valve is broken or damaged, to solve this fault replace the valve by the new one that has been provided.
- No display: The battery level could be low or might be due to a connection fail, charge the battery or check the USB cable connection.

## 12. Storage and transportation

- Keep the equipment in a dry and clean place, with good ventilation and free of corrosive gases. The recommended temperature is from 0 to 40°C and the recommended humidity in a maximum of 80%.
- It is recommended that the battery is charged at least, every month and with a minimum of 50% of the total battery.
- During his transport, prevent the equipment from wetting and suffering shocks that could damage the device.

## 13. Limitations and Compatibility

It is recommended to confirm reagent's compatibility with this instrument before using:

- The liquid path of your digital burette is made of borosilicate glass, FEP and PTFE. Do not use with liquids such as hydrofluoric acid.
- The instrument would be clogged or damaged by solid particles in turbid liquid like activated carbon.
- The plastic parts of your digital burette would be in swelling condition if concentrated acid and alkaline, and methylbenzene, benzene and other nonpolar organic solvents are put into use.
- Keep your digital burette away from the highly combustible carbon disulphide.
- Digital burette cannot be autoclaved.
- Do not put your digital burette in contact with corrosive gas like HCL smog.

## Compatibility (Max. Conc. 1 mol/L)

- Acetic acid
- Alcoholic potassium hydroxide solution
- Ammonium iron (II) sulphate solution
- Ammonium thiocyanate solution
- Barium chloride solution
- Bromide bromate solution
- Cerium (IV) sulphate solution
- EDTA solution
- Hydrochloric acid
- Hydrochloric acid in Acetone
- Iodine solution\*
- Iodide iodate solution\*
- Iron (II) sulphate solution
- Nitric acid
- Oxalic acid solution
- Perchloric acid
- Perchloric acid in glacial acetic acid
- Potassium bromate solution
- Potassium bromate bromide solution
- Potassium dichromate solution
- Potassium hydroxide solution
- Potassium iodate solution
- Potassium permanganate solution\*
- Potassium thiocyanate solution
- Silver nitrate solution\*
- Sodium arsenite solution
- Sodium carbonate solution
- Sodium chloride solution
- Sodium hydroxide solution
- Sodium nitrite solution
- Sodium thiosulfate solution
- Sulfuric acid
- Tetra-n-butylammonium hydroxide sol.
- Triethanolamine in Acetone\*
- Zinc sulphate solution

## 14. Technical characteristics

Specifications	Parameters
Volume Range [mL]	0.01-99.99
Increment	10 $\mu$ L
Precision	R=0.2%; CV=0.07%
Velocity	16
Battery	Capacity: 4000 mA/h Fully charged in 4 hours (please use standard charger) Working time: about 5 hours

## 15. Limitations of Use

- Temperature: 15~40°C
- Vapor pressure: < 500 mbar
- Viscosity: < 500 mm<sup>2</sup>/s
- Humidity: 20 ~ 90%

**Nota importante para los aparatos electrónicos vendidos en España**  
**Important note for electronic devices sold in Spain**  
**Remarque importante pour les appareils électroniques vendus en Espagne**

**Instrucciones sobre la protección del medio ambiente y la eliminación de aparatos electrónicos:**



Los aparatos eléctricos y electrónicos marcados con este símbolo no pueden desecharse en vertederos.  
De conformidad con la Directiva 2002/96/ CE, los usuarios de la Unión Europea de aparatos eléctricos y electrónicos, tienen la oportunidad de retornar el instrumento para su eliminación al distribuidor o fabricante del equipo después de la compra de uno nuevo. La eliminación ilegal de aparatos eléctricos y electrónicos es castigada con multa administrativa.

**Nota importante para los aparatos electrónicos vendidos en Francia**  
**Important note for electronic devices sold in France**  
**Remarque importante pour les appareils électroniques vendus en France**

**Informations sur la protection du milieu environnemental et élimination des déchets électroniques :**



Les appareils électriques et électroniques portant ce symbole ne peuvent pas être jetés dans les décharges.  
En réponse à la réglementation, Labbox remplit ses obligations relatives à la fin de vie des équipements électriques de laboratoire qu'il met sur le marché en finançant la filière de recyclage de Récyllum dédiée aux DEEE Pro qui les reprend gratuitement (plus d'informations sur [www.recyllum.com](http://www.recyllum.com)).  
L'élimination illégale d'appareils électriques et électroniques est punie d'amende administrative.

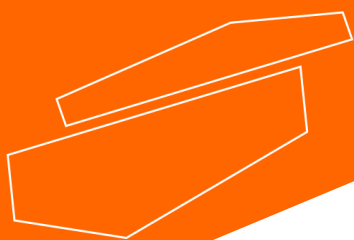

[www.labbox.com](http://www.labbox.com)