

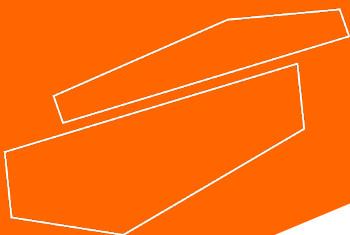

WB-S Multifunctional Water Bath Shaker

Please read the User Manual carefully before use, and follow all operating and safety instructions!



user manual

english



WB-S Multifunctional Water Bath Shaker

Preface

Thank you for purchasing our Water Bath. Users should read this manual carefully, follow the instructions and procedures, and beware of all the preventive measures when using this instrument.

Service

If help is needed, you can always contact your dealer or Labbox via www.labbox.com

Please, provide the customer service representative with the following information:







- Serial number (on the back side)
- Description of the problem
- Your contact information

Warranty

This instrument is guaranteed to be free from defects in materials and workmanship under normal use and service, for a period of 24 months from the date of invoice. The warranty is extended only to the original purchaser. It shall not apply to any product or parts that have been damaged due to improper installation, improper connections, misuse, accident or abnormal conditions of operation.

For claim under the warranty, please contact your supplier.

1. Safety Instructions

	Connect the device to an earthed socket to ensure the safety of the machine and the experiment. Make sure the voltage is the same as required by the device.
	The use of this instrument in flammable, explosive, poisonous, or highly corrosive environments or with hazardous substances is forbidden.
	Place the incubator on a horizontal, flat, clean, non-slip and stable surface. Adjust the feet so that the device is leveled.
	This item must only be used by qualified staff that has read the instructions manual and knows how to operate it.
	Do not place the device near any heat source. Keep away from high magnetic fields. Do not put volatile, flammable and explosive materials in the machine, otherwise it could cause an explosion or a fire.
	Non-professionals must not disassemble or repair this machine.
	Read the instructions manual before using this device.

- When working, wear the necessary personal protective equipment to avoid the risk of:
 - Burns caused by contact with hot surfaces or materials
 - Burns caused by splashing and evaporation of liquids
 - Intoxication caused by release of toxic or flammable gases
- The device and accessories must be checked prior to every use. Do not use damaged components.
- Beware of hazards due to:
 - Flammable materials or media with a low boiling temperature
 - Overfilling of vessels
 - Unsafe vessel
- Do not cover the device.
- Do not expose the device to rain, moisture or splashing as this might result in electrical leakage, short-circuit or electric shock.
- In case the device is let idle or unsupervised, ensure the door is completely closed.
- Unplug by pulling always from the plug. Never pull from the wire.
- Do not connect the power cord to the middle section.

- Ensure that the main cable does not touch the surface.
- Do not damage the power cord and always use the specified one. In case of damage, the power cord must be replaced.
- Do not unplug the power cord during operation.
- Unplug the cord before maintenance, after use, and if the instrument is running abnormally.
- Do not touch the power plug with wet hands.
- Wear gloves when repairing and maintaining the instrument.

Other necessary considerations:

- When touching the inner wall of the door, do it carefully, as it may be hot.
- The internal parameters must be set by the specific management person to prevent the function of the controller program from being disturbed by an unknown setting.
- The equipment must be placed at least 20cm away from the wall and from any objects.
- Open and close the door gently to prevent damage to the equipment.
- Do not expose the equipment surface to volatile chemicals.
- Keep the equipment clean, both the inside and the outside.

Safety alarms:

- In case of a controller block, Holzer error, busbar under voltage, busbar over voltage or communication failure, the speed bar will show the fault code and the controller will automatically stop.
- In case of a temperature or speed alarm, the identifier **ALM1** will light up and the buzzer sound will go off. Stop it by pressing any key.
- When turning off the equipment, always press  to stop any ongoing functions before turning off the device.
- In case of a fault of the temperature sensor or the controller itself, the indicator – will display. Carefully check the temperature sensor and its wiring.

2. Description





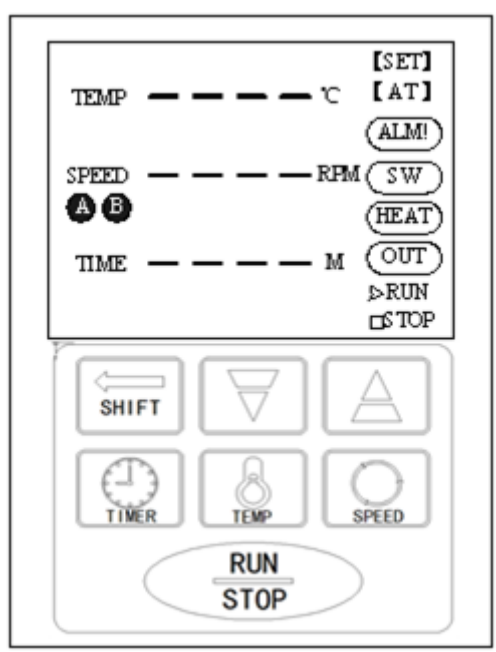

2.1. Technical specifications

Mode		Reciprocating oscillation + thermostatic water bath
Function	Operating Temp Range	RT~100°C
	Temperature Resolution Ratio	0.1°C
	Temperature Motion	±0.1°C
	Temperature Uniformity	±0.2°C
	Reciprocal Oscillation Amplitude	16 or 24mm (Ex-factory is 24mm)
	Reciprocating Frequency Range	20~200 (r/min)
	Reciprocating Frequency Accuracy	±1rpm
Structure	Water Tank	Mirror stainless steel
	Outer Shell	Cold rolling steel electrostatic spraying exterior
	Upper Cover	Mirror stainless steel
	Insulating Layer	Polyurethane
	Heater	Stainless Steel Heater
	Driving Mode	Crankshaft+ double link + four wheels
	Shelf	Mirror stainless steel
	Power rating	1.5kW
Controller	Temperature Control Mode	LCD PID Intelligent control
	Reciprocating Control Mode	
	Setting Mode	Touch button setting
	Temp. Display Mode	LCD Display
	Speed Display Mode	
	Timer	0~9999 min
	Operation Function	<ul style="list-style-type: none"> · fixed value operation · timing function · auto stop · quick stop-start
	Temperature Sensor	Pt100
	Speed Sensor	Hoare
Additional Functions	<ul style="list-style-type: none"> · deviation correction · menu keys lock · power-off memory 	
Device safety		<ul style="list-style-type: none"> · over-temperature alarm · menu lock

		<ul style="list-style-type: none"> · full water tank or water shortage protection · motor shaft lock protection
Specification	Water Tank Size (W*L*H) (mm)	500*310*200
	Exterior Size (W*L*H) (mm)	828*360*425
	Packing Size (W*L*H) (mm)	908*440*505
	Spring Shock Basket Size (mm)	395*250
	Shock Basket Largest Single Size (ml /piece)	100ml*12/250*8/500*6
	Inside Volume	31L
	Shock Basket Bearing	5kg/layer
	Current Rating (50Hz)	AC220V/6.8A
	NW/GW (kg)	20/30
Accessories		<ul style="list-style-type: none"> · water bath flask seat · tube rack

2.2. Control Keys







-  - Press to increase the parameter value by one. Keep pressed to continuously increase the value.
-  - Press to reduce the parameter value by one. Keep pressed to continuously reduce the value.
-  - Press to navigate through the parameters.
-  - Press to enter time value setting mode. Press again to return to home screen.
-  - Press to enter temperature value setting mode. Press again to return to home screen.
-  - Press to enter speed value setting mode. Press again to return to home screen.
-  - Press to start running the device functions. Press again to stop.

3. Temperature internal parameter settings mode

3.1. How to use





In order to enter the temperature internal parameter setting mode, the user must introduce the password. To do that, follow these steps:

1. Press  for 3 seconds.
 - The screen will display **Lc**
 - The speed area of the screen will display the password value
2. Use   to choose the required password value. See password values below.
3. Press  to enter the value.

If the password is *incorrect*, the display will return to the home screen.

If the password is *correct*, the display will show the temperature internal parameter settings mode.

Then:

1. Press  to modify each parameter.
2. Use   to choose desired value.
3. Press  for 3 seconds to return to the home screen.

If no key is pressed for 1 minute, the display will return to the home screen.

3.2. Internal parameters tables

INDICATOR	NAME	FUNCTION DESCRIPTION	(RANGE) DEFAULT VALUE
Lc	Password	The password to modify the parameters in this table is Lc = 3	0
ALH	Upper deviation over temperature alarm	$\text{temperature measurement} > \text{temperature set value} + \text{AL}$ THEN · the alarm light is turned on · the buzzer calls · the heating output is disconnected.	(0~20.0°C) 5.0
T	Control cycle	Heating control cycle.	(1~60s) 5
P	Proportional band	Time proportional adjustment.	(0.1~50.0) 15.0
I	Integration time	The integral function is adjusted.	(1~2000s) 380
d	Differential time	Differential action regulation.	(0~2000s) 100
LT	Floodlight time	Time the floodlight stays ON every time. When Lt=0 , the delay is invalid and the lights need to be turned off manually.	(0~9999min) 0

St-	Sterilization lamp off-delay	Time the sterilization lamp stays ON every time. When St=0 , the delay is invalid and the lights need to be turned off manually.	(0~9999min) 0
Pb	Temperature correction	Correction of errors caused by sensor low temperature measurement. $Pb = \frac{\text{actual temperature} - \text{measured value}}{\text{measured value}}$	(-99.9~99.9°C) 0
PL	Slope correction	Correction of errors caused by sensor high temperature values. $PL = 1000 \times \left[\frac{\text{actual temperature value} - \text{temperature measured value}}{\text{temperature measured value}} \right]$	(-999~999) 0





INDICATOR	NAME	FUNCTION DESCRIPTION	FACTORY VALUE
Lc	Password	The password to modify the parameters in this table is Lc = 9	0
Pon	Power down memory function	0: OFF – if the power goes off, the controller will stop working. 1: ON – if the power goes off, when the device is turned on again it will continue running the functions it was running when the power went off.	(0~1) 0
ruT	RUN/STOP key delay	Time after which the function of the RUN/STOP button will be effective	(0~10s) 0
nP	Maximum power output	The maximum power percentage of the heating output.	(0~100%) 100
Co	Turn off the heating output deviation	IF temperature measurement \geq temperature set value + Co THEN the heating output is turned OFF.	(0.0~20.0°C) 5.0
SPH	Upper temperature limit	Upper limit of temperature set point	(0.0~200.0°C) 100.0
Adr	mailing address	The local communication address.	(1~32) 1

INDICATOR	NAME	FUNCTION DESCRIPTION	FACTORY VALUE
Lc	Password	The password to modify the parameters in this table is Lc = 576	0
rST	Factory reset	0: Do not restore the factory value 1: Restore the factory value. Including: · internal parameters table 1, 2 and 6 · parameters Fr , DB and dF from internal parameters table 5	(0~1) 0

4. Speed internal parameter settings

4.1. How to use





In order to enter the temperature internal parameter setting mode, the user must introduce the password. To do that, follow these steps:

4. Press  for 3 seconds.
 - The screen will display **Lc**
 - The speed area of the screen will display the password value
5. Use   to choose the required password value. See password values below.
6. Press  to enter the value.

If the password is *incorrect*, the display will return to the home screen.

If the password is *correct*, the display will show the temperature internal parameter settings mode.

Then:

4. Press  to modify each parameter.
5. Use   to choose desired value.
6. Press  for 3 seconds to return to the home screen.

If no key is pressed for 1 minute, the display will return to the home screen.

4.2. Internal parameter tables

INDICATOR	NAME	FUNCTION DESCRIPTION	FACTORY VALUE
Lc	Password	The password to modify the parameters in this table is Lc = 3	0
Pd	Proportional gain	Speed proportional gain.	(1 ~ 100) 10
Id	Integral coefficient	Speed integral coefficient.	(1 ~ 100) 5
InT	Acceleration time	Time it takes for the motor to accelerate to the new set speed.	(1 ~ 60) 10
dET	Deceleration time	Time it takes for the motor to decelerate to the new set speed.	(1 ~ 60) 10
SdL	Speed lower limit	Minimum speed setting	(20 ~ 500) 20
SdH	Speed upper limit	Maximum speed setting	(20 ~ 500) 300





INDICATOR	NAME	FUNCTION DESCRIPTION	FACTORY VALUE
Lc	Password	The password to modify the parameters in this table is Lc = 9	0
EAr	Gear ratio	$EAr = \frac{\text{big gear diameter}}{\text{pinion diameter}}$	(1.0~10.0) 1.0
PoL	Pole logarithm of motor	The DC brushless motor is extremely logarithmic.	(1~32) 4
dIF	Motor rotation reference direction	0 : clockwise rotation is the positive direction 1 : counterclockwise rotation is the positive direction	(0~1) 0
FdS	Speed feedback value	Speed feedback system value	(0.1~10.0) 1.0
FdC	Current feedback value	Current feedback system value	(0.1~10.0) 1.0
FrE	Carrier frequency	Brushless motor carrier frequency <u>Note</u> : when this parameter is changed, the controller needs to be restarted.	(5~15) 15
Po	Motor power	Brushless motor power. <u>Note</u> : this parameter must be adjusted according to the actual power of the motor.	(1~100) 60
CL	Overflow multiple	Allowable current multiplier for overcurrent protection of the motor.	(1.0~10.0) 5.0
Fr	Rotation direction selection of motor	0 : The motor only runs in forward rotation. 1 : The motor only runs in reverse. 2 : The motor can run in both directions.	(0~2) 0
db	Insensitive display area	Speed display insensitive area	(0~100) 2
dF	False display	Reservation is invalid	

5. Time internal settings

5.1. How to use

Setting the rotation times













When **Fr = 0** or **Fr = 1**, the motor only runs in one direction, forward or reverse, respectively. In that case, follow these instructions to set the rotation time:

1. Press  → the temperature screen will display **AT**.
2. Use   to choose the motor running time.
3. Press  to enter the value and return to the home screen.

Once the timer goes off, it will make a buzzer sound and display **End**. Stop it by pressing any key. To restart the operation, press .

Note: when the timer is set to 0, the equipment will run continuously until it is stopped manually.





When **Fr = 2**, the motor can alternate between the two rotating directions. To set the different rotation and stopping times, follow the next instructions:

1. Set the FORWARD rotation time:
 - i. Press  → the indicator **Fd** will show.
 - ii. Use   to choose the motor forward running time.
 - iii. Press  to enter the value.
2. Set the STOPPING time:
 - i. Once you press  the indicator **P** will show.
 - ii. Use   to choose the motor stopping time.
 - iii. Press  to enter the value.
3. Set the REVERSE rotation time:
 - i. Once you press  the indicator **Rd** will show.
 - ii. Use   to choose the motor stopping time.
 - iii. Press  to enter the value and return to the home screen.

Note: the forward, stopping, and reverse rotation times can be selected in minutes. The total time can be selected in hours and minutes. See below how to select the unit.

Modifying the time internal parameters





In order to enter the temperature internal parameter setting mode, the user must introduce the password. To do that, follow these steps:

1. Press  for 3 seconds.
 - The screen will display **Lc**
 - The speed area of the screen will display the password value
2. Use   to choose the required password value. See password values below.
3. Press  to enter the value.

If the password is *incorrect*, the display will return to the home screen.

If the password is *correct*, the display will show the temperature internal parameter settings mode.

Then:

1. Press  to modify each parameter.
2. Use   to choose desired value.
3. Press  for 3 seconds to return to the home screen.

If no key is pressed for 1 minute, the display will return to the home screen.







5.2. Internal parameter table

INDICATOR	NAME	FUNCTION DESCRIPTION	FACTORY VALUE
Lc	Password	The password to modify the parameters in this table is Lc = 3	0
ndT	Timing mode selection	<p>0: when the timer goes off, stop the speed only, not the temperature.</p> <p>1: when the timer goes off, stop the speed AND the temperature.</p> <p>2: The timer starts to count after reaching the temperature set value. When the timer goes off, stop the speed only, not the temperature.</p> <p>3: The timer starts to count after reaching the temperature set value. When the timer goes off, stop the speed AND the temperature.</p> <p><u>Note:</u> This parameter cannot be modified during operation. If you do that, the timer will restart.</p>	(0~3) 1
Hn	Total time units	<p>0: Time is measured in minutes – m is displayed.</p> <p>1: Time is measured in hours – h is displayed.</p> <p><u>Note:</u> This parameter cannot be modified during operation.</p>	(0~1) 0
SPd	Constant temperature deviation	<p style="text-align: center;">IF</p> $\text{temperature measurement} \geq \text{temperature set value} - \text{SPd}$ <p style="text-align: center;">THEN the equipment enters the constant temperature state.</p>	(0.1~100.0°C) 0.5

EST	Time end prompting time	Time for which the buzzer sound is on when the timer goes off. <u>Note:</u> when EST=9999 , the buzzer sound time is indefinite	(0~9999s) 60
rT	Total time error correction	Correct the total timing error $\text{correction value} = \frac{10 \times [\text{run time (s)} - \text{actual time (s)}]}{\text{actual time (s)}}$	

6. System self-tuning

When the temperature control effect is not ideal, a system self-tuning can be carried out where the equipment will automatically configure its PID parameters. To do that, follow the next instructions:

1. Press  during 6 seconds  enter the self-tuning state selection
 - The temperature section will display **AT**.
 - The speed display section will display **OFF**.
2. Use   to select ON or OFF. Select **ON** to activate the self-tuning function.
3. Press  to enter  self-tuning will begin.
 - The **AT** indicator will flash until self-tuning ends. Once it stops flashing, the new parameters will be automatically saved.

To abort the process at any time, press  for 6 seconds or turn off the controller.

Note: during this process, the setting keys do not work.

7. Wiring diagram

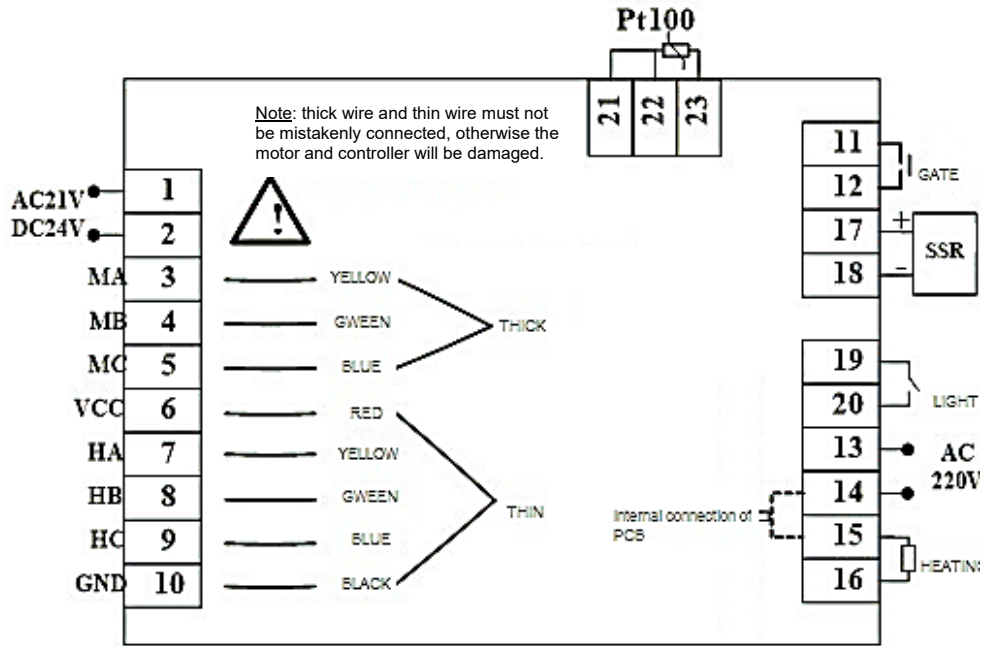

MASTER DRIVE BOARD WIRING LAYOUT

1. Power out by AC24V Transformer, regardless of plus-minus when connection
2. MTZSH5-C1005 Series without lighting function (without 19, 20 terminal)
3. With MTZB Type, the PT100 Sensor can be connected to the 21/22/23 terminal; MTZSH Type without 21/22/23 terminal, the PT100 sensor needs to be connected behind the display panel

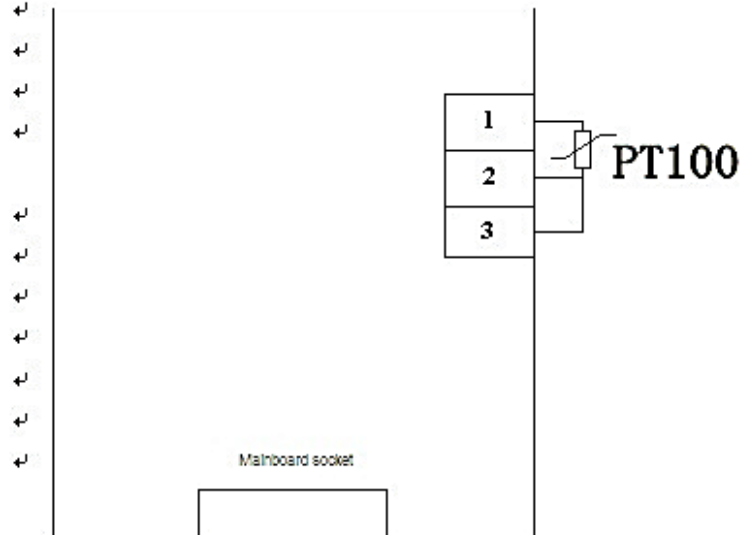

8. General faults and troubleshooting

Failure phenomenon	Fault analysis	Troubleshooting
Equipment is ON but the display is not.	Power supply is not connected	Check if the power outlet has power
	The power plug is not plugged in	Check the contact between the power plug and the socket
	The power switch is not on	Turn on the power switch on the right side of the instrument
	Damage of the fuse on the box	Replacement of a power fuse with the same specification
Sharp drop in the water level in the sink	Continuous high temperature operation causes rapid evaporation	Refill the water tank in time before too much water evaporates
	Drain valve leak	Repair or replace the drain valve
	Water tank seepage	Notify the factory to get the it repaired
Instability of the shaking plate	The instrument is not stable	Adjust the foot of the instrument to stabilize the instrument
	External object at the bottom of the plate	Remove the object
	Control circuit fault	Notify the factory to get it repaired
The measured temperature is higher than the set temperature and the system enters the high-temperature alarm state.	The water level is too low	Increase the water level so that it is higher than the heating tube and the sensor
	The instrument has not yet entered the state of constant temperature	Wait for a moment and check again
	Temporary high-temperature phenomenon	Correct the temperature setting
	Heater anomaly	Notify the factory to get it repaired
The measured temperature is lower than the set temperature and the system enters the low-temperature alarm state.	The lid of the is not properly closed and heat is constantly exuding the instrument	Close the lid properly and do not open it too frequently.
	The instrument has not yet entered the state of constant temperature	Wait for a moment and check again
	Heater anomaly	Notify the factory to get it repaired
The noise of the instrument is too loud	The instrument is not placed properly	Adjust the foot of the instrument to stabilize the instrument
	The flask clamp fixing screw is loose	Remove the flask and the plate and tighten the screw
	Shake plate loosening	Tighten the screws at the four corners of the plate
	Bump on the bottom of the plate due to an object	Remove the object
	Mechanical failure	Notify the factory to get it repaired

Nota importante para los aparatos electrónicos vendidos en España

Instrucciones sobre la protección del medio ambiente y la eliminación de aparatos electrónicos:



Los aparatos eléctricos y electrónicos marcados con este símbolo no pueden ser eliminados en forma de residuos urbanos.

De conformidad con la Directiva 2012/19/UE, los usuarios de la Unión Europea de aparatos eléctricos y electrónicos, tienen la posibilidad de devolver sus RAEE para su eliminación al distribuidor o fabricante del equipo después de la compra de uno nuevo. La eliminación ilegal de aparatos eléctricos y electrónicos es castigada con multa administrativa.

Remarque importante pour les appareils électroniques vendus en France

Informations sur la protection du milieu environnemental et élimination des déchets électroniques :



Les appareils électriques et électroniques portant ce symbole ne peuvent pas être jetés dans les décharges.

En réponse à la réglementation, Labbox remplit ses obligations relatives à la fin de vie des équipements électriques de laboratoire qu'il met sur le marché en finançant la filière de recyclage de ecosystem dédiée aux DEEE Pro qui les reprend gratuitement (plus d'informations sur www.ecosystem.eco).

L'élimination illégale d'appareils électriques et électroniques est punie d'amende administrative.

Nota importante per le apparecchiature elettroniche vendute in Italia

Istruzioni sulla protezione ambientale e sullo smaltimento dei dispositivi elettronici:



Le apparecchiature elettriche ed elettroniche contrassegnate con questo simbolo non possono essere smaltite come rifiuti urbani.

In conformità con la Direttiva 2012/19 / UE, gli utenti dell'Unione Europea di apparecchiature elettriche ed elettroniche hanno la possibilità di restituire i propri RAEE per lo smaltimento al distributore o al produttore di apparecchiature dopo averne acquistato uno nuovo. La rimozione illegale di apparecchiature elettriche ed elettroniche è punibile con una sanzione amministrativa.

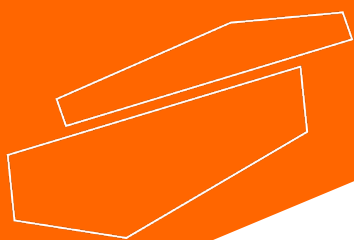

www.labbox.com